

PRODUCT DESCRIPTION

RoSep oil separators are used everywhere where there is possibility that mineral oils will come into rivers, streams, lakes or nature.

Inside the oil separator, a coalescent filter is installed. Coalescent filter serves to purify meteoric waste water up to 5 mg/l of the mineral oil content at the outlet. Automatic closure device at the outlet prevent the extraction of mineral oils from the oil separator into the environment.

The integrated sample point on the oil separator allows easy sampling for the needs of measurements of the concentration of the mineral oil content at the outlet.





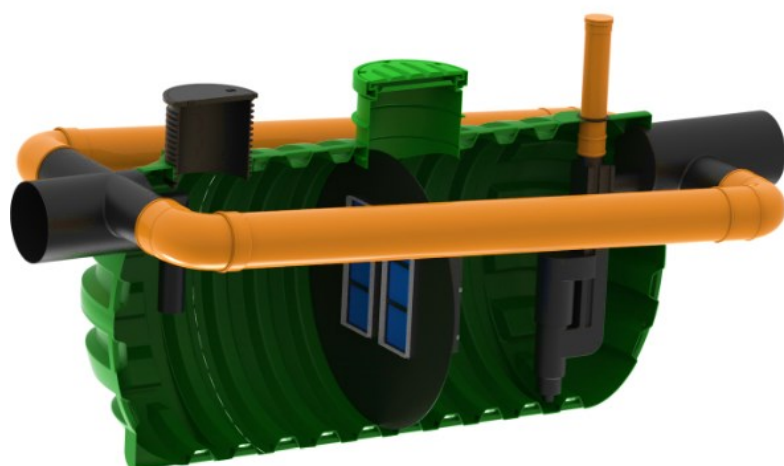





Oil separators are made of nature friendly polyethylene (PE), which can be 100 % recycled after use.

It is dimensioned and tested according to the standards SIST EN 858 – 1 and SIST EN 858 – 2.

TECHNICAL DATA RoSep NS 500/50 S-I-P
BY PASS 10 %

Technical data	Values
Total flow	500 L/s
Flow through the oil separator	50 L/s
Flow through the By-pass	450 L/s
Total volume	16000 L
Settler volume	5950 L
Oil separator volume	6130 L
Maximum oil amount	3110 L
Installation	Underground installation
Dimension L x D x Hmin - Hmax	3760 x 2310 x 2350 - 2850
Diameter of revision openings	Φ 600, Φ 800
Inflow and outflow diameter	DN 600
Oil content at the outlet	< 5 mg/L – I. Class
Standards	SIST EN 858-1, SIST EN 858-2
UV resistant material	Yes
Coalescent filter	Yes
Cover	PE walk - on cover
Water outflow	To surface or ground water

ROSEP OIL SEPARATOR ADVANTAGES

-  **High cleaning efficiency**
-  Simple maintenance
-  **Long life service**
-  Easy and fast installation
-  **Integrated sample point**
-  Telescopic adjustable riser
-  **Easy accesable coalescent filter**
-  Calming inlet pipe
-  **Automatic closure device**
-  Integrated By-pass 10 %
-  **Slovenian product**

CLEANING EFFICIENCY

Cleaning efficiency: Total hydro carbons: **2,7 mg / L**

Cleaning efficiency checked (Report no.: 113 – 10 / 4433 – 10 / 1 – IS) by the institute:

Institute for health care Maribor, Prvomajska 1, 2000 Maribor



MECHANICAL RESISTANCE AND STABILITY

Mechanical resistance and stability checked (Report no.: P 0865 / 12 – 680 – 2)

Slovenian national building and civil engineering institute, Dimičeva ulica 12, 1000 Ljubljana



WATERTIGHTNESS

Watertightness checked (Report no.: P 0865 / 12 – 680 – 1) by the institute:

Slovenian national building and civil engineering institute, Dimičeva ulica 12, 1000 Ljubljana

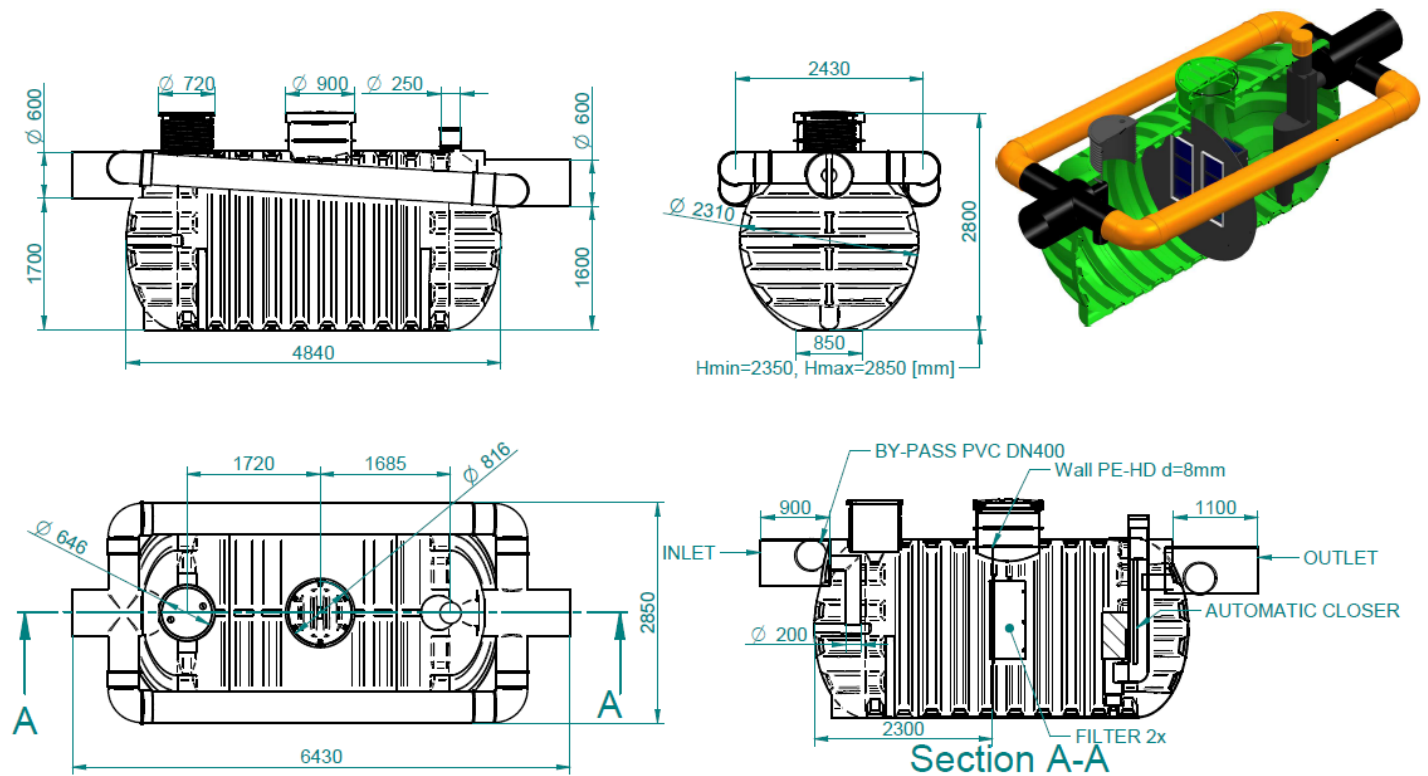

ADDITIONAL INFORMATIONS

INSTALLATION

The installation of oil separators is simple and fast. To install the oil separator, excavate the pit, install the oil separator and fill it with the water at the same time. Connect it with the inflow and the outflow pipes (DN 400 connections).

Oil separators can be installed by Roto experts. Installation must be made according to the general instructions accessed on the QR code.



Instructions for
installation

OPERATION

Water contaminated with oil, fats and other sludges flows into the first chamber, whereby the inlet knee takes care of the calming the water. The sedimentary chamber has the function of a sludge trap, sand, fine sludge and other rough dirt. The larger oil droplets rises to the level in the sedimentary chamber, while the remaining water contaminated with small droplets of oil flows through the coalescent filter. In the second chamber the remaining oil is risen to the surface. The purified water of light liquids from the second chamber drains through the outflow pipe to the drainage system, thus protecting the nature against potential pollution.

Oil separators with the installed By-Pass is constructed for high flow rates. In the case of the major rain, 90 % of the water flows through the bypass and the other 10 % goes through the oil separator.

MAINTENANCE

The control of the oil separator should be carried out in accordance with the procedure and must be written in operating diary. Control must be made after every major rainfall and a longer dry season. Checking the oil trap includes checking the amount of sewage sludge and floating oil on the surface.

Maintenance of the oil separator involves removing sludge, floating oil and cleaning the components of the device. The maintenance period shall be determined on the basis of the actual load at the initial stage of operation. Cleaning of the device should be carried out by an authorized person who ensures that the waste is handled in accordance with legal regulations.

COALESCENT FILTER AND AUTOMATIC CLOSURE DEVICE

The coalescent filter is installed in the PE housing on guides in the chamber wall and can be easily pulled out. Greater droplets of oil float on the surface due to the lower density of water. Small droplets that did not raise in the first chamber, flows through the coalescent filter and join into larger droplets, thereby increasing their volume and buoyancy, which contributes to the remaining part of the oil rising to the surface. The filter is attached to the removable housing, which is easily pulled over the guides of the chamber wall from the oil separator. Coalescent filter can be cleaned with a high pressure cleaner.

The automatic closure device is installed in the second chamber. The automatic closing mechanism closes automatically in the event of an exceeded maximum oil level in the separator.

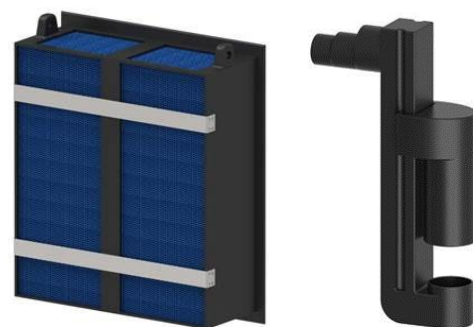

Roto Eco d.o.o.

Puconci 12, 9201 Puconci,

SLOVENIA

Customer support: (+386) 2 5252 152

Technical support: (+386) 2 5252 196

Web page: www.roto-group.eu

All rights reserved, including the rights of photomechanical reproductions and storage on electronic media. The manufacturer reserves the rights to change the product. Any commercial use of the processes and working procedures assumed in this document is prohibited. Although information, texts and photos were carefully collected. The mistakes can not be completely excluded. The publisher and editors can not assume legal responsibility or guarantee any incorrect information. The publisher and editors are grateful for any possible suggestions for improvements and warnings of possible mistakes in the text.