

PRODUCT DESCRIPTION

RoOil separators are used everywhere where the possibility that mineral oil will come into rivers, streams, lakes or nature.

Inside the oil separator, a coalescence filter is installed. Coalescent filter serves to purify meteoric waste water up to 5 mg/l of the mineral oil content at the outlet. Automatic closure device at the outlet prevent the extraction of mineral oils from the oil separator into the environment.

The integrated measuring point on the oil separator allows for easy sampling for the needs of measurements of the concentration of the mineral oil content at the outlet.











Oil separator is made of naturally-friendly polyethylene (PE), which can be 100 % recycled after use.

It is dimensioned and tested according to the standards SIST EN 858 – 1 and SIST EN 858 – 2.

TECHNICAL DATA RoOil NS 50/10 S-I-P
BY PASS 20 %

Technical data	Values
Skupni pretok	75 L/s
Flow through the separator	15 L/s
Flow through By-Pass	60 L/s
Total volume	4000 L
Settler volume	2600 L
Oil separator volume	420 L
Maximum oil amount	530 L
Installation	Underground installation
Dimension D x H	Φ 1800 x 2500 [mm]
Diameter of revision openings	Φ 800 [mm]
Inflow and outflow pipe diameter	DN 315
Oil content at the outlet	< 5 mg/L – I. class
Standard	SIST EN 858-1, SIST EN 858-2
UV resistant material	Yes
Coalescent filter	Yes
Cover	PE walk - on cover
Water outflow	To surface or ground water

ROOIL OIL SEPARATOR ADVANTAGES

-  **High cleaning efficiency**
-  Simple maintenance
-  **Long life service**
-  Easy and fast installation
-  **Integrated sample point**
-  Revision openings Φ 600
-  **Coalescent filter**
-  Integrated By-Pass 20%
-  **Calming inlet pipe**
-  Automatic closure device
-  **Slovenian product**

MECHANICAL RESISTANCE AND STABILITY

Mechanical resistance and stability checked (Report no.: P 0087 / 17 – 680 – 2)

Slovenian national building and civil engineering institute, Dimičeva ulica 12, 1000 Ljubljana



WATERTIGHTNESS

Watertightness checked (Report no.: P 0087 / 17 – 680 – 1)

Slovenian national building and civil engineering institute, Dimičeva ulica 12, 1000 Ljubljana

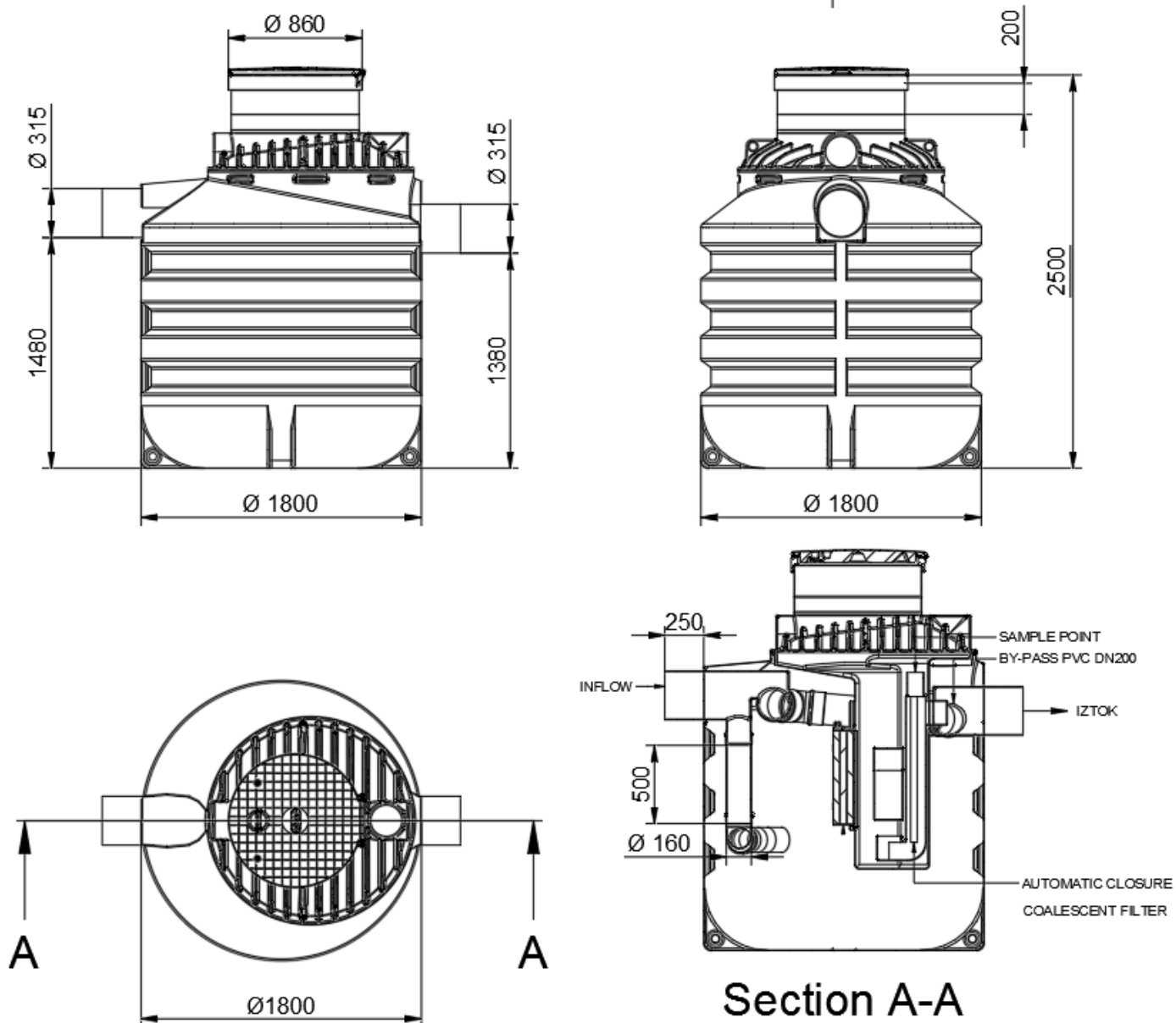

ADDITIONAL INFORMATIONS

INSTALLATION

The installation of the RoOil is easy and fast, and without need for heavy machinery. To install the oil separator, excavate the pit, install the oil separator and fill with the water at the same time. Connect it with the inflow and the outflow pipes (DN 315 connections).

Oil separators can be installed by Roto experts. Installation must be made according to the general instructions accessed on the QR code.



*Instructions for
installation*

OPERATION

Water contaminated with oil, fats and other sludges flows into the first chamber, whereby the inlet tube takes care of the calming the water. The sedimentary chamber has the function of a sludge trap, sand, fine sludge and other rough dirt. The larger oil droplets rise to the level in the sedimentary chamber, while the remaining water contaminated with small droplets of oil flows through the coalescent filter. In the second chamber the remaining oil is risen to the surface. The purified water of light liquids from the second chamber drains through the effluent to the drainage system, thus protecting the nature against potential pollution.

Oil separators with the installed By-Pass is constructed for high flow rates. In the case of the major rain 80 % of the water flows through the bypass and the other 20 % goes through the oil separator.

MAINTENANCE

The control of the oil separator should be carried out in accordance with the procedure and must be written in operating diary. Control must be made after every major rainfall and a longer dry season. Checking the oil trap includes checking the amount of sewage sludge and floating oil on the surface.

Maintenance of the oil trap involves removing sludge, floating oil and cleaning the components of the device. The maintenance period shall be determined on the basis of the actual load at the initial stage of operation. Cleaning of the device should be carried out by the authorized person who ensures that the wastes is handled in accordance with the legal regulations.

COALESCENT FILTER AND AUTOMATIC CLOSURE DEVICE

The coalescent filter is installed in the PE housing in the chamber wall. Greater droplets of oil float on the surface due to the lower density of water. Small droplets that did not rise in the first chamber, flows through the coalescent filter and join into larger droplets, thereby increasing their volume and buoyancy, which contributes to the remaining part of the oil rising to the surface.

The filter is attached to the movable housing, which is easily pulled over the guides of the chamber wall from the oil separator. Coalescent filter can be cleaned with a high pressure cleaner.

The automatic closure device is installed in the second chamber. The automatic closing mechanism closes automatically in the event of an exceeded maximum oil level in the separator.

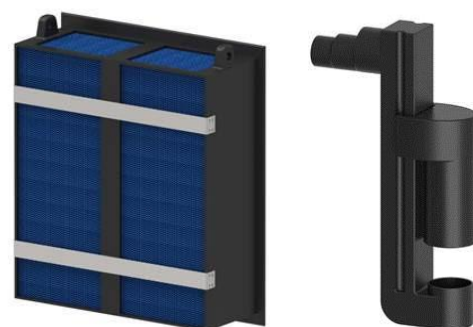

Roto Eco d.o.o.

Puconci 12, 9201 Puconci,

SLOVENIA

Customer support: (+386) 2 5252 152

Technical support: (+386) 2 5252 196

Web page: www.roto-group.eu

All rights reserved, including the rights of photomechanical reproductions and storage on electronic media. The manufacturer reserves the rights to change the product. Any commercial use of the processes and working procedures assumed in this document is prohibited. Although information, texts and photos were carefully collected. The mistakes can not be completely excluded. The publisher and editors can not assume legal responsibility or guarantee any incorrect information. The publisher and editors are grateful for any possible suggestions for improvements and warnings of possible mistakes in the text.