

PRODUCT DESCRIPTION

With RoSeptic 3 chamber tanks, we collect fecal waste water from the households of the facilities where the public sewerage is not regulated.

Their use is sensible and practical especially for households with one or two population units or for holiday facilities where there is no permanent inflow.

The recommended volume of the septic tanks is 1500 L per person.

Waste water of the non-flowing septic tank must be emptied regularly. Discharge of municipal waste water takes place through an opening at the top.

With the correct installation a septic tank is also suitable for installations under traffic loads.

TECHNICAL DATA RoSeptic 3C 25000 L

Technical data	Values
Total volume	25000 L
Dimensions L x D x H [mm]	7370 x 2300 x 2550 - 2850
Installation	Underground installation
Diameter of revision openings	3 x Φ 600 mm
Material	Polyethylene [PE]
UV material stability	Yes
Inflow pipe diameter	DN 110
Outflow pipe diameter	/
Standard	SIST EN 12566 - 1
Cover	PE walk-on cover

ROTO SEPTIC TANKS ADVANTAGES

- Fast and simple installation**
- Long life service
- Monolithic tank**
- Telescopic adjustable extension
- Possibility of diferent inflow pipes**
- Slovenian product
- Covers with hinge**

MECHANICAL RESISTANCE AND STABILITY

Mechanical resistance and stability checked (Report no.: P 0865 / 12 – 680 - 2) by the institute:
Slovenian national building and civil engineering institute, Dimičeva ulica 12, 1000 Ljubljana



WATERTIGHTNESS

Watertightness checked (Report no.: P 0865 / 12 – 680 – 1) by the institute:
Slovenian national building and civil engineering institute, Dimičeva ulica 12, 1000 Ljubljana

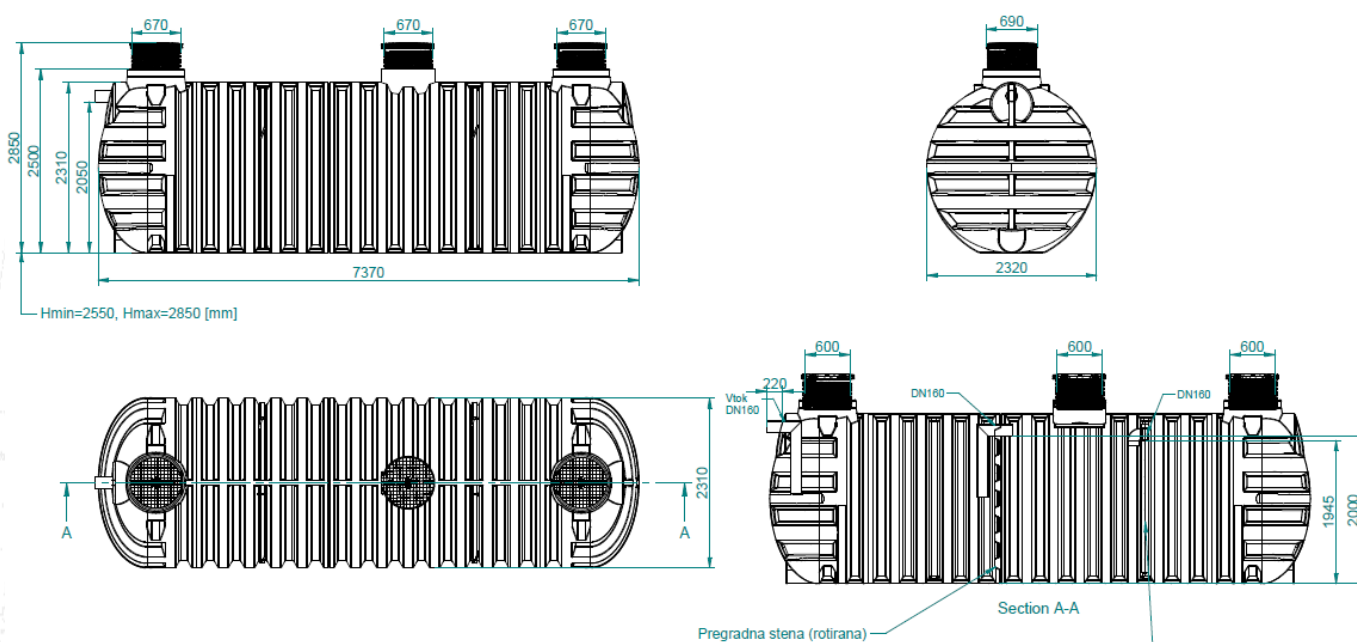

ADDITIONAL INFORMATIONS

INSTALLATION OF THE ROSEPTIC

Tank installation is fast and simple and can be made in few hours. Excavate the pit, install the tank and fill with the water at the same time. Connect it to the inflow and the outflow pipes (various standard pipes possibility). Tank can be installed by Roto experts. Installation must be made according to general instructions accessed on the QR code.



Roto Eco d.o.o.

Puconci 12, 9201 Puconci,

SLOVENIA

Customer support: (+386) 2 5252 152

Technical support: (+386) 2 5252 196

Web page: www.rotoECO.eu

All rights reserved, including the rights of photomechanical reproductions and storage on electronic media. The manufacturer reserves the rights to change the product. Any commercial use of the processes and working procedures assumed in this document is prohibited. Although information, texts and photos were carefully collected. The mistakes can not be completely excluded. The publisher and editors can not assume legal responsibility or guarantee any incorrect information. The publisher and editors are grateful for any possible suggestions for improvements and warnings of possible mistakes in the text.

